

TORINDRIVE

NORTH AMERICA



HYPERION

ELEVATOR

TRACTION MACHINES

> GEARED

> MINI GEARLESS

> LARGE GEARLESS

> MRL

> BASEMENT

> SUB SYSTEMS

> COMPONENTS

www.torindrivena.com



ELEVATOR
TRACTION MACHINE

GEARED SYSTEMS

TGD

> GEARED PACKAGE

- > World-Class Geared Machine
- > Emergency Sheave Brake Installed and Adjusted
- > Universal Bedplate System with Cross Beams
- > Isolation Pads and Deflector Sheave
- > Flange Mount Motor for Easy Handling



STANDARD AND
CUSTOM ROPE
GUARD SETS





OVERHEAD GEARED MACHINE APPLICATION TABLE

1:1 or 2:1 Roping and Single Wrap TGD SERIES

- > A17.1 Compliance
- > CSA B44.1/ASTM A17.5 Certification
- > Bronze gear
- > Incremental encoder: 2048 pulses per revolution
- > Geared machine can be ordered as Right hand or Left hand
- > Common machine models have high voltage (480V) and low voltage (208V) options
- > TGD0, TGD1, and TGD2 come with optional sheave brake (SB) as emergency brake
- > TGD3-SC comes with optional sheave clamp (SC) as emergency brake

PART NUMBER ILLUSTRATION

TGD1	25	35	HV	R	SB	1/2
Geared Machine Series	Capacity 2500lbs	Speed 350fpm	Voltage 480V	Hand Right	Emergency Brake Sheave Brake	Rope Size 1/2

1:1 ROPING DUTY TABLE

Capacity (lbs)	Speed (fpm)									
	100	150	200	250	300	350	400	450	500	
1500	TGD0-1715		TGD0-1720	TGD0-1735			TGD1-2540	TGD2-2550		
1760										
2000	TGD1-2510	TGD1-2020		TGD1-2535						
2500		TGD1-2520								
3000	TGD2-3520			TGD2-3535	TGD2-3540	TGD3-3545	TGD3-3550			
3500										
4000	TGD3-5020			TGD3-4535	TGD3-4540	TGD3-4545				
4500										
5000				TGD3-5535	TGD3-5545					
5500	TGD3-5520									
6000	TGD3-6020			TGD3-6035		TGD3-6045				
7000	TGD3-7020									
8000	TGD4-12020			TGD4-8035						
9000										
10000				TGD4-10030						

2:1 ROPING DUTY TABLE

Capacity (lbs)	Speed (fpm)					
	100	150	175	200	225	250
3520	TGD0-1720	TGD0-1735		TGD1-2540	TGD2-2550	
4000	TGD1-2020	TGD1-2535				
5000	TGD1-2520					
7000	TGD2-3520	TGD2-3535	TGD2-3540	TGD3-3545	TGD3-3550	
9000	TGD3-5020		TGD3-4535	TGD3-4540	TGD3-4545	
10000	TGD3-5520		TGD3-5535		TGD3-5545	
11000						
12000	TGD3-6020	TGD3-6035		TGD3-6045		
14000	TGD3-7020	TGD4-8035				
16000						
20000	TGD4-12020	TGD4-10030				
24000						

Power Wiring Diagram

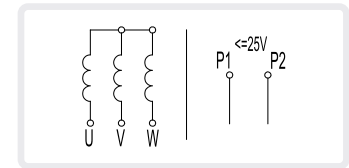

> Single Voltage

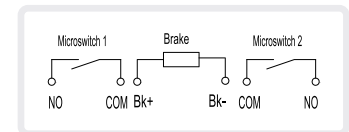

> Normal Brake Wiring Diagram

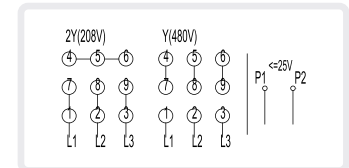

> Dual Voltage

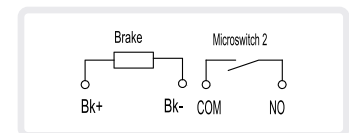

> Sheave Brake Wiring Diagram

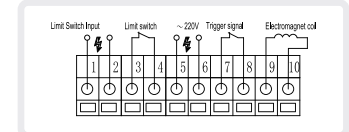

> Sheave Clamp Wiring Diagram

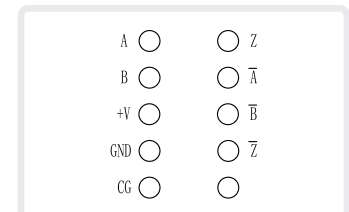

> Encoder Connection Terminal

TGDO SERIES

OVERHEAD GEARED MACHINE

- **SHEAVE SHAFT LOAD:** 9,900 lbs
- **SHEAVE GROOVES:** Up to 5X1/2" ropes
- **ESTIMATED WEIGHT:** 1,450 lbs
- **NORMAL BRAKE**
 - Pick/Hold Voltage: 110/67 VDC
 - Pick/Hold Current: 1.1/0.67 A
- **EMERGENCY BRAKE**
 - Pick/Hold Voltage: 110/60 VDC
 - Pick/Hold Current: 2.75/1.4 A

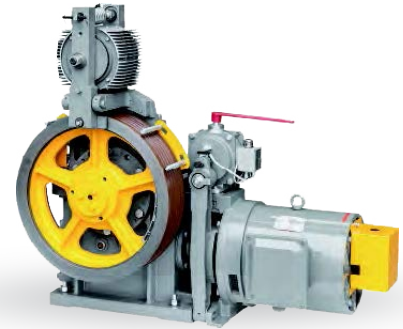

MODEL NUMBER	Capacity (lbs)	Speed (fpm)	Roping	Motor Rating (HP)	Poles	Rated Motor RPM	Rated Voltage (VAC)	Rated Frequency (HZ)	Rated FLA (A)	No Load Current (A)	Gear Ratio	Application Motor RPM	CWT (%)	Sheave Diameter
TGDO-1715-DV	1760	150	1:1	10	6	1170	480/208	60	13.5/29	7/12.5	41:1	1126	40	20.9"
TGDO-1720-DV	1760	200	1:1	12	4	1770	480/208	60	14.5/32	6/10	41:1	1501	40	20.9"
TGDO-1735-DV	1760	350	1:1	20	4	1770	480/208	60	24/51.5	9/15.5	47:2	1506	40	20.9"

TGD1 SERIES

OVERHEAD GEARED MACHINE

- **SHEAVE SHAFT LOAD:** 16,500 lbs
- **SHEAVE GROOVES:** Up to 6X1/2" or 5X5/8" ropes
- **ESTIMATED WEIGHT:** 2,215 lbs
- **NORMAL BRAKE**
 - Pick/Hold Voltage: 110/65 VDC
 - Pick/Hold Current: 2.0/1.18 A
- **EMERGENCY BRAKE**
 - Pick/Hold Voltage: 110/60 VDC
 - Pick/Hold Current: 2.75/1.4 A

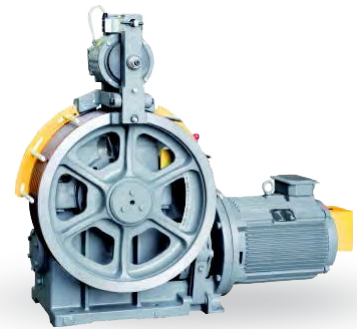

MODEL NUMBER	Capacity (lbs)	Speed (fpm)	Roping	Motor Rating (HP)	Poles	Rated Motor RPM	Rated Voltage (VAC)	Rated Frequency (HZ)	Rated FLA (A)	No Load Current (A)	Gear Ratio	Application Motor RPM	CWT (%)	Sheave Diameter
TGD1-2020-HV/LV	2000	200	1:1	15	4	1770	480/208	60	17/39	7.8/15	50:1	1493	40	25.6"
TGD1-2510-HV/LV	2500	100	1:1	10	6	1170	480/208	60	14/32	8.9/19.5	61:1	911	40	25.6"
TGD1-2520-HV/LV	2500	200	1:1	20	4	1775	480/208	60	23/53	11/24	50:1	1493	40	25.6"
TGD1-2535-HV/LV	2500	350	1:1	25	4	1770	480/208	60	28/64	12/27.4	61:2	1593	40	25.6"
TGD1-2540-HV/LV	2500	400	1:1	30	4	1775	480/208	60	33/75	14/29	55:2	1642	40	25.6"

TGD2 SERIES

OVERHEAD GEARED MACHINE

- **SHEAVE SHAFT LOAD:** 24,200 lbs
- **SHEAVE GROOVES:** Up to 8X1/2" or 6X5/8" ropes
- **ESTIMATED WEIGHT:** 2,618 lbs
- **NORMAL BRAKE**
 - Pick/Hold Voltage: 110/65 VDC
 - Pick/Hold Current: 2.0/1.18 A
- **EMERGENCY BRAKE**
 - Pick/Hold Voltage: 110/65 VDC
 - Pick/Hold Current: 3.6/1.7 A



MODEL NUMBER	Capacity (lbs)	Speed (fpm)	Roping	Motor Rating (HP)	Poles	Rated Motor RPM	Rated Voltage (VAC)	Rated Frequency (HZ)	Rated FLA (A)	No Load Current (A)	Gear Ratio	Application Motor RPM	CWT (%)	Sheave Diameter
TGD2-2545-HV/LV	2500	450	1:1	35	4	1770	408/208	60	40/87.5	15/26	49:2	1646	40	25.6"
TGD2-2550-HV/LV	2500	500	1:1	35	4	1770	480/208	60	40/87.5	15/26	70:3	1741	40	25.6"
TGD2-3520-HV/LV	3500	200	1:1	25	4	1770	480/208	60	28/64	12/27.4	50:1	1493	40	25.6"
TGD2-3535-HV/LV	3500	350	1:1	35	4	1770	480/208	60	40/87.5	15/26	61:2	1593	40	25.6"
TGD2-3540-HV	3500	400	1:1	40	4	1770	480	60	45	16	55:2	1642	40	25.6"

TGD3 SERIES

OVERHEAD GEARED MACHINE

- **SHEAVE SHAFT LOAD:** 31,900 lbs
- **SHEAVE GROOVES:** Up to 8X5/8" ropes
- **ESTIMATED WEIGHT:** 3,290 lbs
- **NORMAL BRAKE**
 - Pick/Hold Voltage: 200/118 VDC
 - Pick/Hold Current: 4.0/2.36 A



MODEL NUMBER	Capacity (lbs)	Speed (fpm)	Roping	Motor Rating (HP)	Poles	Rated Motor RPM	Rated Voltage (VAC)	Rated Frequency (HZ)	Rated FLA (A)	No Load Current (A)	Gear Ratio	Application Motor RPM	CWT (%)	Sheave Diameter
TGD3-3550-HV	3500	500	1:1	50	4	1770	480	60	55	19	82:3	1657	40	31.5"
TGD3-6020-HV	6000	200	1:1	40	4	1770	480	60	45	16	61:1	1691	40	27.6"
TGD3-6035-HV	6000	350	1:1	60	4	1770	480	60	66	21	69:2	1674	40	27.6"
TGD3-6045-HV	6000	450	1:1	60	4	1770	480	60	66	21	61:2	1665	45	31.5"
TGD3-7020-HV	7000	200	1:1	50	4	1770	480	60	55	19	61:1	1691	45	27.6"

TGD3-SC SERIES

OVERHEAD GEARED MACHINE

- **SHEAVE SHAFT LOAD:** 27,500 lbs
- **SHEAVE GROOVES:** Up to 8X5/8" ropes
- **ESTIMATED WEIGHT:** 3,200 lbs
- **NORMAL BRAKE**
 - Pick/Hold Voltage: 200/118 VDC
 - Pick/Hold Current: 4.0/2.36 A
- **EMERGENCY BRAKE**
 - Pick/Hold Voltage: AC220 (always on)
 - Pick/Hold Current: 0.24/0.12 A

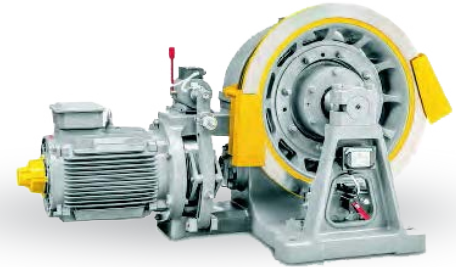

MODEL NUMBER	Capacity (lbs)	Speed (fpm)	Roping	Motor Rating (HP)	Poles	Rated Motor RPM	Rated Voltage (VAC)	Rated Frequency (HZ)	Rated FLA (A)	No Load Current (A)	Gear Ratio	Application Motor RPM	CWT (%)	Sheave Diameter
TGD3-3545-HV-SC	3500	450	1:1	50	4	1770	480	60	55	19	82:3	1705	40	27.6"
TGD3-4535-HV-SC	4500	350	1:1	50	4	1770	480	60	55	19	69:2	1674	40	27.6"
TGD3-4540-HV-SC	4500	400	1:1	50	4	1770	480	60	55	19	61:2	1691	40	27.6"
TGD3-4545-HV-SC	4500	450	1:1	60	4	1770	480	60	66	21	82:3	1705	40	27.6"
TGD3-5020-HV-SC	5000	200	1:1	35	4	1770	480	60	40	15	61:1	1691	40	27.6"
TGD3-5520-HV-SC	5500	200	1:1	35	4	1770	480	60	40	15	61:1	1691	45	27.6"
TGD3-5535-HV-SC	5500	350	1:1	50	4	1770	480	60	55	19	69:2	1674	45	27.6"
TGD3-5545-HV-SC	5500	450	1:1	60	4	1770	480	60	66	21	82:3	1705	45	27.6"

TGD4 SERIES

OVERHEAD GEARED MACHINE

- **SHEAVE SHAFT LOAD:** 55,000 lbs
- **SHEAVE GROOVES:** Up to 12X5/8" or 10X3/4" ropes for 32.3"; 8X5/8" or 7X3/4" ropes for 35.8"
- **ESTIMATED WEIGHT:** 6,160 lbs
- **NORMAL BRAKE**
 - Pick/Hold Voltage: 110/70 VDC
 - Pick/Hold Current: 3.5/2.0 A

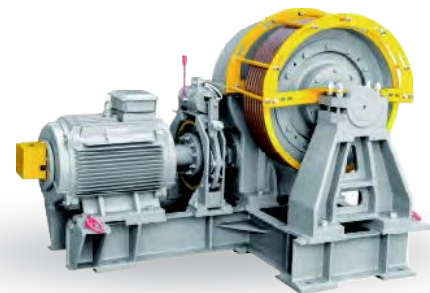

MODEL NUMBER	Capacity (lbs)	Speed (fpm)	Roping	Motor Rating (HP)	Poles	Rated Motor RPM	Rated Voltage (VAC)	Rated Frequency (HZ)	Rated FLA (A)	No Load Current (A)	Gear Ratio	Application Motor RPM	CWT (%)	Sheave Diameter
TGD4-8035-HV	8000	350	1:1	74	6	1184	480	60	78	23	63:2	1175	40	35.8"
TGD4-10030-HV	10000	300	1:1	74	6	1184	480	60	78	23	63:2	1118	48	32.3"
TGD4-12020-HV	12000	200	1:1	74	8	886	480	60	85	34	75:2	886	40	32.3"

OVERHEAD GEARED MACHINE

Technical Details

TGD0 SERIES

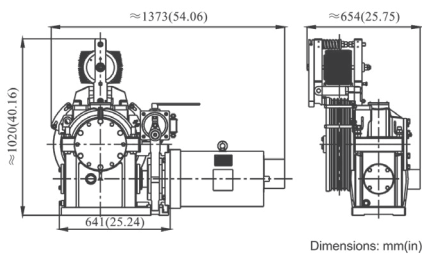

TGD1 SERIES

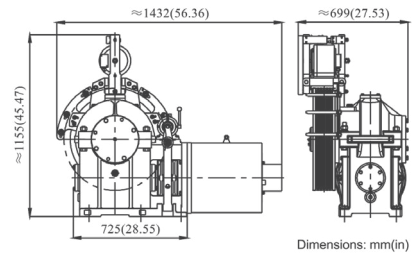

TGD2 SERIES

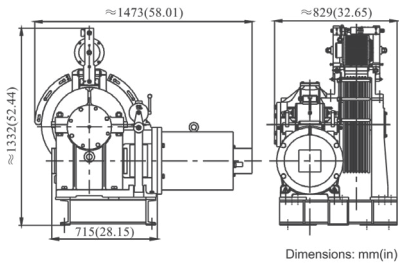

TGD3 SERIES

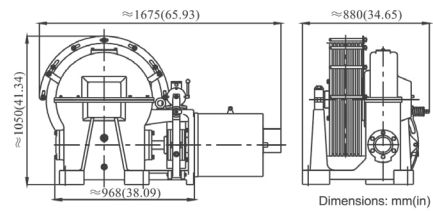

TGD3-SC SERIES

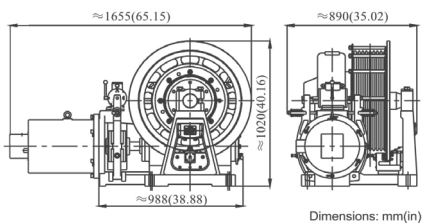

TGD4 SERIES

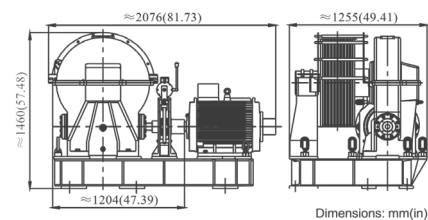

ELEVATOR
TRACTION MACHINE

MINI GEARLESS SYSTEMS

TMGL

> GEARLESS PACKAGE

- > World-Class Gearless Machine
- > Universal Bedplate System with Cross Beams and Isolation Pads
- > Low Maintenance
- > No Oil Leaks and Energy-Efficient
- > Machine Weight as Low as 2,090 lbs
- > 2'x3' Machine for Small Footprint
- > Ideal for Geared to Gearless MOD

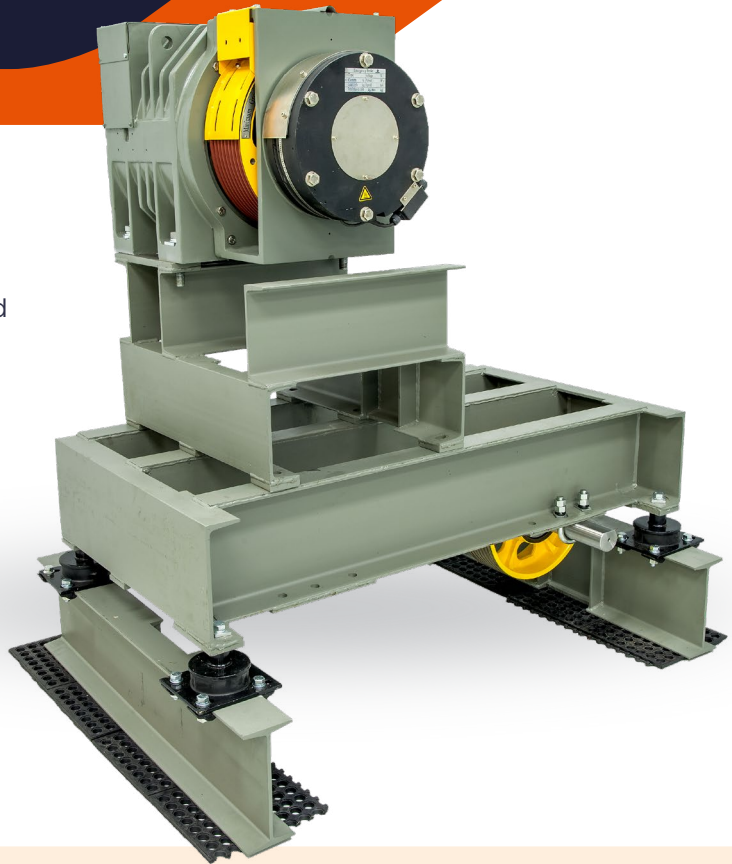

STANDARD AND
CUSTOM ROPE
GUARD SETS





MINI GEARLESS APPLICATION TABLE

1:1 or 2:1 Roping and Single Wrap TMGL SERIES

- > A17.1 Compliance
- > CSA B44.1/ASTM A17.5 Certification (CSA File No.243553)
- > Energy efficient PM motor
- > Absolute encoder: Heidenhain ECN1313 with 2048 pulses per revolution
- > Controller UPS battery is needed to electrically operate the brakes in case of power outage
- > Load weigher is recommended for Mini Gearless machine application

PART NUMBER ILLUSTRATION

TMGL2A ▾	25 ▾	35 ▾	HV ▾	1/2 ▾
Mini Gearless Machine Series	Capacity 3500lbs	Speed 350rpm	Voltage Suitable for 460V Inverter	Rope Size 1/2"

1:1 ROPING DUTY TABLE FOR MINI GEARLESS MACHINE

Capacity (lbs)	Speed				
	200	350	500	1000	1400
2500	TMGL2A-2520	TMGL2A-2535	TMGL2A-3050	TMGL2A-2-1-5050	TMGL2A-2-1-5070
3000	TMGL2A-3035				
3500	TMGL2-3520	TMGL2-3535	TMGL2-3550		
4500	TMGL3-4535				

2:1 ROPING DUTY TABLE FOR MINI GEARLESS MACHINE

Capacity (lbs)	Speed				
	100	175	250	500	700
5000	TMGL2A-2520	TMGL2A-2535	TMGL2A-3050	TMGL2A-2-1-5050	TMGL2A-2-1-5070
6000	TMGL2A-3035				
7000	TMGL2-3520	TMGL2-3535	TMGL2-3550		
9000	TMGL3-4535				

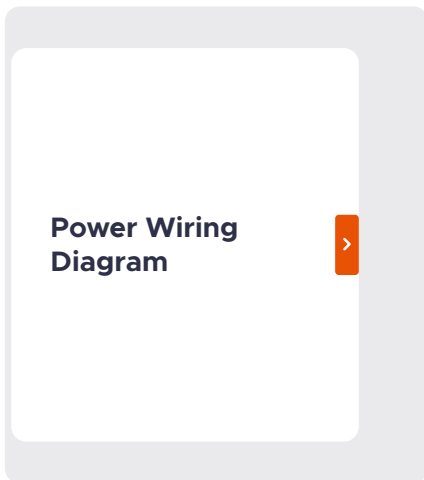

Power Wiring Diagram

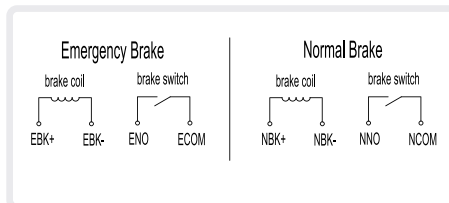
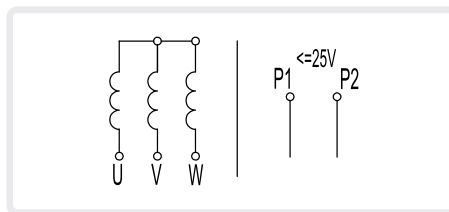

> Brake Wiring Diagram

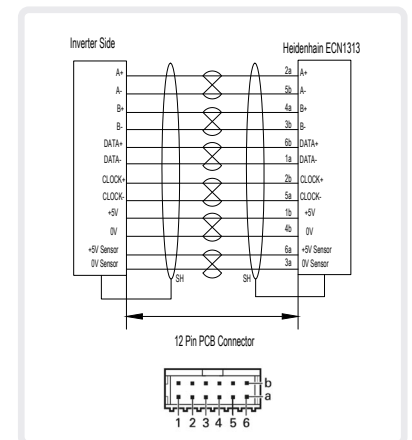

> Encoder Connection Terminal



TMGL2

SERIES 10MM ROPE

MINI GEARLESS

- **SHEAVE SHAFT LOAD:** 20,000 lbs
- **SHEAVE GROOVES:** Up to 10X10mm ropes
- **ESTIMATED WEIGHT:** 2,310 lbs
- **NORMAL BRAKE**
 - Pick/Hold Voltage: 90/45 VDC
 - Pick/Hold Current: 2.05/1.0 A
- **EMERGENCY BRAKE**
 - Pick/Hold Voltage: 90/45 VDC
 - Pick/Hold Current: 2.05/1.0 A



MODEL NUMBER	Capacity (lbs)	Speed (fpm)	Roping	Motor Rating (HP)	Poles	Rated Motor RPM	Rated Voltage (VAC)	Rated Frequency (HZ)	Rated Current (A)	Rated Torque (ft-lbs)	Max Acceleration Torque (ft-lbs)	Cwt (%)	Sheave Diameter
TMGL2-3520-HV	3500	200	1:1	13	20	47	350	7.9	22.3	1438	3190	45	16.14"
TMGL2-3535-HV	3500	350	1:1	22.7	20	83	350	13.8	36.5	1438	3190	45	16.14"
TMGL2-3550-HV	3500	500	1:1	32.4	20	118	350	19.7	50	1438	3190	45	16.14"

TMGL2A

SERIES 1/2" ROPE

MINI GEARLESS

- **SHEAVE SHAFT LOAD:** 20,000 lbs/17500lbs for TMGL2A(2- 1)
- **SHEAVE GROOVES:** Up to 6X1/2" ropes
- **ESTIMATED WEIGHT:** 2,500 lbs
- **NORMAL BRAKE**
 - Pick/Hold Voltage: 90/45 VDC
 - Pick/Hold Current: 2.05/1.0 A
- **EMERGENCY BRAKE**
 - Pick/Hold Voltage: 90/45 VDC
 - Pick/Hold Current: 2.05/1.0 A



MODEL NUMBER	Capacity (lbs)	Speed (fpm)	Roping	Motor Rating (HP)	Poles	Rated Motor RPM	Rated Voltage (VAC)	Rated Frequency (HZ)	Rated Current (A)	Rated Torque (ft-lbs)	Max Acceleration Torque (ft-lbs)	Cwt (%)	Sheave Diameter
TMGL2A-2520-HV/LV	2500	200	1:1	9.3	20	38	350/160	6.4	14.8/30.7	1272	3180	45	20"
TMGL2A-2535-HV/LV	2500	350	1:1	16.2	20	67	350/160	11.1	24.5/52.4	1272	3180	45	20"
TMGL2A-3035-HV/LV	3000	350	1:1	19.4	20	67	350/160	11.1	29.8/61.5	1527	3817	45	20"
TMGL2A-3050-HV	3000	500	1:1	27.7	20	95	350	15.9	42	1527	3817	45	20"
TMGL2A-2-1-5050-HV	5000	500	2:1	49.1	20	191	350	31.8	68.5	1350	3375	45	20"
TMGL2A-2-1-5070-HV	5000	700	2:1	72.2	20	267	350	44.5	108	1420	3550	45	20"

TMGL3

SERIES 1/2" ROPE

MINI GEARLESS

- **SHEAVE SHAFT LOAD:** 25,000 lbs
- **SHEAVE GROOVES:** Up to 10X1/2" ropes
- **ESTIMATED WEIGHT:** 3,600 lbs
- **NORMAL BRAKE**
 - Pick/Hold Voltage: 90/45 VDC
 - Pick/Hold Current: 4.1/2.0 A

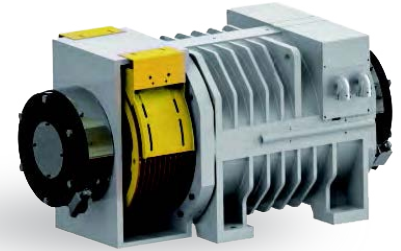

MODEL NUMBER	Capacity (lbs)	Speed (fpm)	Roping	Motor Rating (HP)	Poles	Rated Motor RPM	Rated Voltage (VAC)	Rated Frequency (HZ)	Rated Current (A)	Rated Torque (ft-lbs)	Max Acceleration Torque (ft-lbs)	Cwt (%)	Sheave Diameter
TMGL3-4535-HV	4500	350	1:1	31.9	20	67	350	11.1	49	2497	6242	45	20"

MINI GEARLESS

Technical Details

TMGL2 SERIES

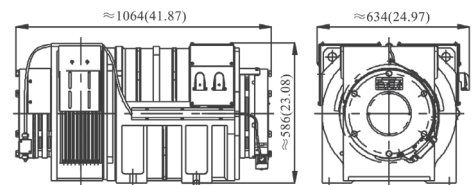

Dimensions: mm(in)

TMGL2A SERIES

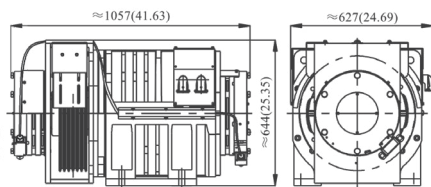

Dimensions: mm(in)

TMGL3 SERIES

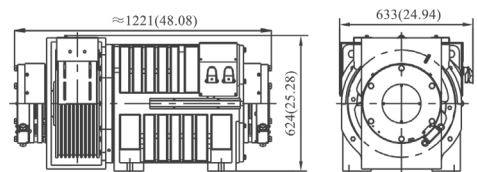

Dimensions: mm(in)

ELEVATOR
TRACTION MACHINE

LARGE PM GEARLESS TGL

> GEARLESS PACKAGE

- > World-Class Gearless Machines
- > Customized Bedplate Systems Matching Machine Room Layouts
- > Dual Brakes with Independent Normal and Emergency Brakes for Most of Series
- > Isolation Pads and Deflector Sheave

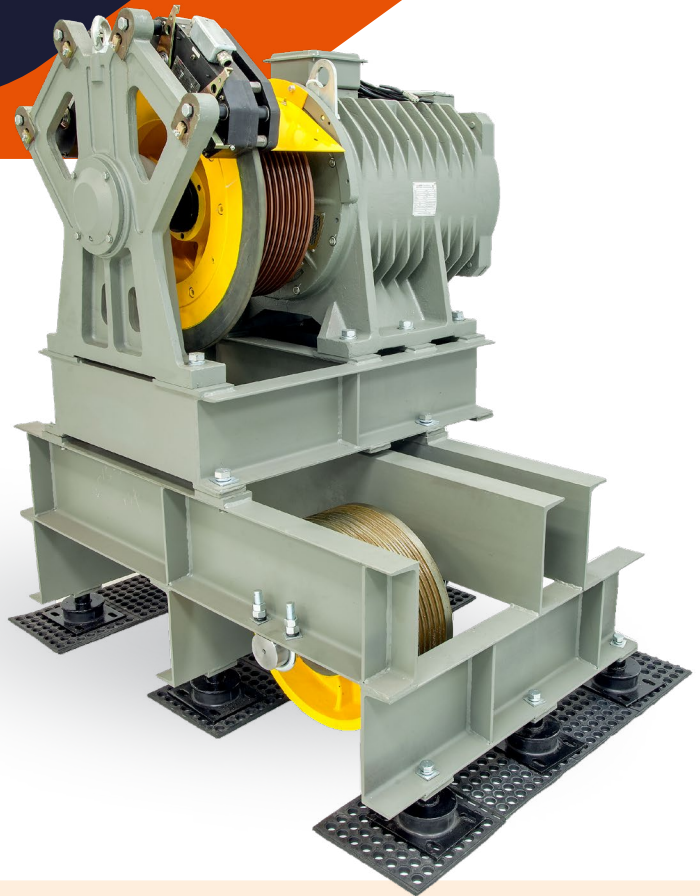

**CUSTOMIZED
ROPE
GUARD SETS**



LARGE PM GEARLESS MACHINES

1:1 or 2:1 Roping and Single Wrap or Double Wrap TGL SERIES

- > A17.1 Compliance
- > CSA B44.1/ASTM A17.5 Certification (CSA File No.243553)
- > Absolute encoder: Heidenhain ECN1313 with 2048 pulses per revolution
- > Large PM machines has option for single wrap (SW) and double wrap (DW)

PART NUMBER ILLUSTRATION

TGL1	35	70	HV	DW	1/2
Large Gearless Machine Series	Capacity 3500lbs	Speed 700fpm	Voltage Suitable for 460V Inverter	Wrap Double wrap	Rope Size 1/2"

1:1 ROPING DUTY TABLE FOR LARGE GEARLESS MACHINE

Capacity (lbs)	Speed (fpm)							
	350	500	700	800	1000	1200	1400	1600
2500	TGL2-1-1-3535	TGL2-1-1-3550	TGL2-1-1-3570	TGL2A-4080	TGL2-2-1-5050	TGL2-2-1-5070		TGL2-2-1-5080
3500					TGL3-8050	TGL3-8060	TGL3-8070	
4000	TGL2A-4035	TGL2A-4050	TGL2A-4070					
5000	TGL3A-5035	TGL3A-5050						

2:1 ROPING DUTY TABLE FOR LARGE GEARLESS MACHINE

Capacity (lbs)	Speed (fpm)						
	250	350	400	500	600	700	800
3500	TGL2-1-1-3550	TGL2-1-1-3570	TGL2A-4080	TGL1-3550	TGL1-3570		TGL1-3580
5000				TGL2-2-1-5050	TGL2-2-1-5070		TGL2-2-1-5080
7000				TGL3-8050	TGL3-8050	TGL3-8070	
8000	TGL2A-4050	TGL2A-4070					
10000	TGL3A-5050						

Power Wiring Diagram

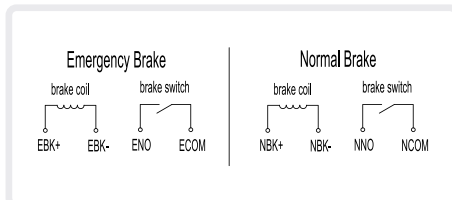
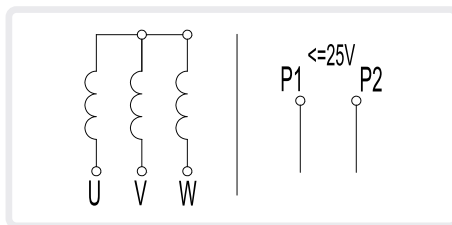

> Brake Wiring Diagram

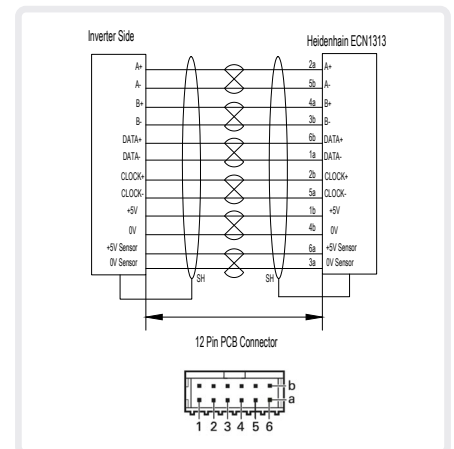

> Encoder Connection Terminal

TGL1 SERIES

LARGE PM GEARLESS MACHINE

- **SHEAVE SHAFT LOAD:** 22,040 lbs
- **WRAP:** Single Wrap (SW) or Double Wrap (DW) Option
- **SHEAVE GROOVES:** Up to 10X1/2" ropes (14 grooves for DW)
- **ESTIMATED WEIGHT:** 3,520 lbs
- **NORMAL BRAKE**
 - Pick/Hold Voltage: 110/55 VDC
 - Pick/Hold Current: 2.3/1.15 A
- **EMERGENCY BRAKE**
 - Pick/Hold Voltage: 110/55 VDC
 - Pick/Hold Current: 2.3/1.15 A



MODEL NUMBER	Capacity (lbs)	Speed (fpm)	Roping	Motor Rating (HP)	Poles	Rated Motor RPM	Rated Voltage (VAC)	Rated Frequency (HZ)	Rated Current (A)	Rated Torque (ft-lbs)	Max Acceleration Torque (ft-lbs)	Cwt (%)	Sheave Diameter
TGL1-3550-HV	3500	500	2:1	34.3	20	173	340	28.8	50	1040	2600	45	22"
TGL1-3570-HV	3500	700	2:1	48.2	20	243	340	40.5	69	1040	2600	45	22"
TGL1-3580-HV	3500	800	2:1	54.9	20	277	340	46.2	79	1040	2600	45	22"

TGL2(2:1) SERIES

LARGE PM GEARLESS MACHINE

- **SHEAVE SHAFT LOAD:** 34,869 lbs
- **WRAP:** Single Wrap (SW) or Double Wrap (DW) Option
- **SHEAVE GROOVES:** Up to 10X1/2" ropes (16 grooves for DW)
- **ESTIMATED WEIGHT:** 4,400 lbs
- **NORMAL BRAKE**
 - Pick/Hold Voltage: 110/55 VDC
 - Pick/Hold Current: 2.3/1.15 A
- **EMERGENCY BRAKE**
 - Pick/Hold Voltage: 110/55 VDC
 - Pick/Hold Current: 2.3/1.15 A



MODEL NUMBER	Capacity (lbs)	Speed (fpm)	Roping	Motor Rating (HP)	Poles	Rated Motor RPM	Rated Voltage (VAC)	Rated Frequency (HZ)	Rated Current (A)	Rated Torque (ft-lbs)	Max Acceleration Torque (ft-lbs)	Cwt (%)	Sheave Diameter
TGL2-2-1-5050-HV	5000	500	2:1	49	20	173	340	28.8	77	1485	4455	45	22"
TGL2-2-1-5070-HV	5000	700	2:1	68.8	20	243	340	40.5	99.8	1485	4455	45	22"
TGL2-2-1-5080-HV	5000	800	2:1	78.4	20	277	340	46.2	125	1485	4455	45	22"

TGL2(1:1) SERIES

LARGE PM GEARLESS MACHINE

- > **SHEAVE SHAFT LOAD:** 34,869 lbs
- > **WRAP:** Single Wrap (SW) or Double Wrap (DW) Option
- > **SHEAVE GROOVES:** Up to 10X1/2" ropes (14 grooves for DW)
- > **ESTIMATED WEIGHT:** 4,400 lbs
- > **NORMAL BRAKE**
 - > Pick/Hold Voltage: 110/55 VDC
 - > Pick/Hold Current: 2.3/1.15 A
- > **EMERGENCY BRAKE**
 - > Pick/Hold Voltage: 110/55 VDC
 - > Pick/Hold Current: 2.3/1.15 A



MODEL NUMBER	Capacity (lbs)	Speed (fpm)	Roping	Motor Rating (HP)	Poles	Rated Motor RPM	Rated Voltage (VAC)	Rated Frequency (HZ)	Rated Current (A)	Rated Torque (ft-lbs)	Max Acceleration Torque (ft-lbs)	Cwt (%)	Sheave Diameter
TGL2-1-1-3535-HV/LV	3500	350	1:1	22.7	20	65.4	300/146	10.9	42/87	1825	4562	45	20.47"
TGL2-1-1-3550-HV/LV	3500	500	1:1	33	20	93	320/145	15.5	56/121	1825	4562	45	20.47"
TGL2-1-1-3570-HV/LV	3500	700	1:1	45.6	20	131	320/140	21.8	76/173	1825	4562	45	20.47"

TGL2A SERIES

LARGE PM GEARLESS MACHINE

- > **SHEAVE SHAFT LOAD:** 45,000 lbs
- > **WRAP:** Single Wrap (SW) or Double Wrap (DW) Option
- > **SHEAVE GROOVES:** Up to 10X1/2" ropes (16 grooves for DW)
- > **ESTIMATED WEIGHT:** 4,620 lbs
- > **NORMAL BRAKE**
 - > Pick/Hold Voltage: 110/55 VDC
 - > Pick/Hold Current: 2.2/1.1 A
- > **EMERGENCY BRAKE**
 - > Pick/Hold Voltage: 110/55 VDC
 - > Pick/Hold Current: 2.2/1.1 A

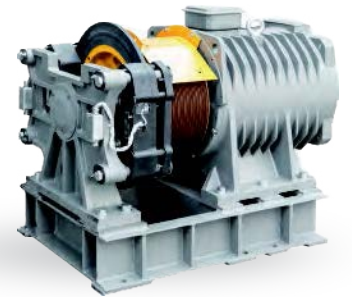

MODEL NUMBER	Capacity (lbs)	Speed (fpm)	Roping	Motor Rating (HP)	Poles	Rated Motor RPM	Rated Voltage (VAC)	Rated Frequency (HZ)	Rated Current (A)	Rated Torque (ft-lbs)	Max Acceleration Torque (ft-lbs)	Cwt (%)	Sheave Diameter
TGL2A-4035-HV	4000	350	1:1	26	20	65.4	325	10.9	48	2086	5215	45	20.47"
TGL2A-4050-HV	4000	500	1:1	37	20	93	325	15.5	64	2086	5215	45	20.47"
TGL2A-4070-HV	4000	700	1:1	52.1	20	131	325	21.8	85	2086	5215	45	20.47"
TGL2A-4080-HV	4000	800	1:1	62.1	20	149	325	24.8	100.5	2191	5477	45	20.47"

TGL3 SERIES

LARGE PM GEARLESS MACHINE

- **SHEAVE SHAFT LOAD:** 89,984 lbs
- **WRAP:** Double Wrap (DW)
- **SHEAVE GROOVES:** Up to 8X5/8" ropes (16 grooves for DW)
- **ESTIMATED WEIGHT:** 6,600 lbs
- **NORMAL BRAKE**
 - Pick/Hold Voltage: 110/55 VDC
 - Pick/Hold Current: 2.2/1.1 A
- **EMERGENCY BRAKE**
 - Pick/Hold Voltage: 110/55 VDC
 - Pick/Hold Current: 2.2/1.1 A



MODEL NUMBER	Capacity (lbs)	Speed (fpm)	Roping	Motor Rating (HP)	Poles	Rated Motor RPM	Rated Voltage (VAC)	Rated Frequency (HZ)	Rated Current (A)	Rated Torque (ft-lbs)	Max Acceleration Torque (ft-lbs)	Cwt (%)	Sheave Diameter
TGL3-8050-HV	8000	500	2:1	78.7	24	139	350	27.8	127	2970	7375	45	27.56"
TGL3-8060-HV	8000	600	2:1	94	24	166	350	33.2	148	2970	7375	45	27.56"
TGL3-8070-HV	8000	700	2:1	109.8	24	194	350	38.8	178	2970	7375	45	27.56"

TGL3A SERIES

LARGE PM GEARLESS MACHINE

- **SHEAVE SHAFT LOAD:** 89,984 lbs
- **WRAP:** Single Wrap (SW) or Double Wrap (DW) Option
- **SHEAVE GROOVES:** Up to 8X5/8" ropes (16 grooves for DW)
- **ESTIMATED WEIGHT:** 6,600 lbs
- **NORMAL BRAKE**
 - Pick/Hold Voltage: 110/55 VDC
 - Pick/Hold Current: 2.2/1.1 A



MODEL NUMBER	Capacity (lbs)	Speed (fpm)	Roping	Motor Rating (HP)	Poles	Rated Motor RPM	Rated Voltage (VAC)	Rated Frequency (HZ)	Rated Current (A)	Rated Torque (ft-lbs)	Max Acceleration Torque (ft-lbs)	Cwt (%)	Sheave Diameter
TGL3A-5035-HV	5000	350	1:1	34.8	24	53	350	10.6	57.5	3445	7375	45	25.6"
TGL3A-5050-HV	5000	500	1:1	49.3	24	75	350	15	79	3445	7375	45	25.6"

LARGE PM GEARLESS MACHINES

Technical Details

TGL1 SERIES

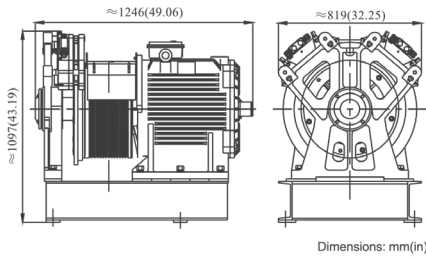

TGL2(1:1) SERIES

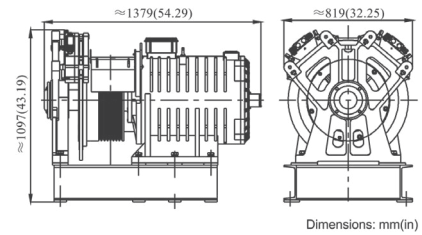

TGL2(2:1) SERIES

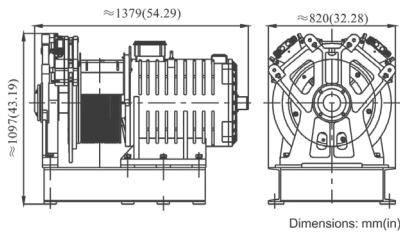

TGL2A SERIES

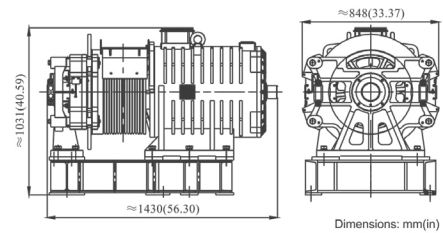

TGL3 SERIES

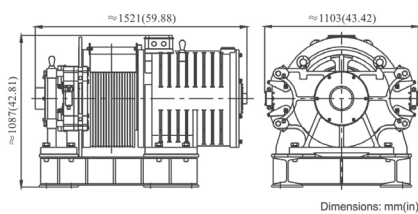

TGL3A SERIES

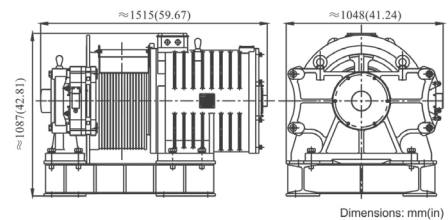

ELEVATOR
TRACTION MACHINE

MACHINE ROOMLESS **MRL**

> TSM / TMSM SERIES (BARREL TYPE)

- > Ideal for Low Overhead
- > Dual Brake System
- > Sheave Shaft Load up to 12,817 lbs
- > 8mm or 10mm Rope

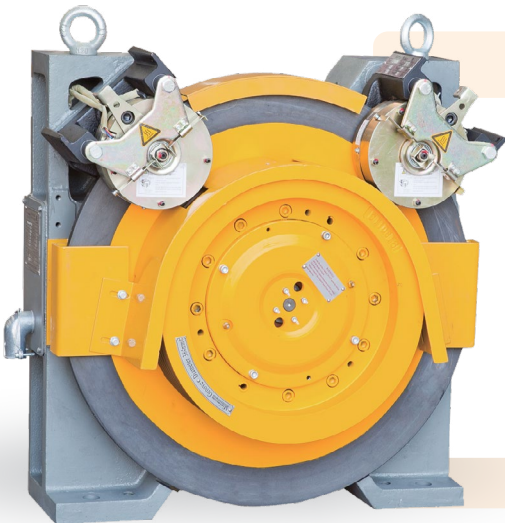
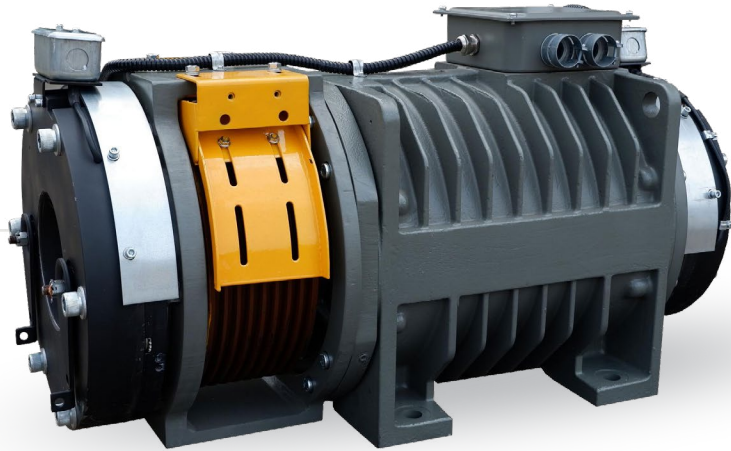

TPM SERIES (PANCAKE TYPE)

- > Ideal for small hoistway arrangements
- > Dual brake system
- > Sheave shaft load up to 9,900 lbs
- > 8mm or 10mm Rope





MACHINE ROOMLESS (MRL) APPLICATION TABLE

2:1 Roping and Single Wrap TPM/TSM/TSM SERIES

- > A17.1 Compliance
- > CSA B44.1/ASTM A17.5 Certification (CSA File No.243553)
- > Energy efficient PM motor
- > MRL machines are single wrap and suitable for 2:1 roping application
- > Dual brake system (No need for rope gripper)
- > Absolute encoder: Heidenhain ECN1313 with 2048 pulses per revolution
- > TPM machines are available in LV and HV options

PART NUMBER ILLUSTRATION

TSM	35	35	HV	10mm
MRL Machine Series	Capacity 3500	Speed 350fpm	Voltage Suitable for 460V Inverter	Rope Size 10mm

2:1 ROPING DUTY TABLE FOR MRL- 10MM ROPE

Capacity (lbs)	Speed (fpm)		
	200	350	500
2500	TPM2-2520-10mm	TPM2-2535-10mm	TSM-3550
3500	TPM4-3520	TPM4-3535 TSM-3535	
5000	TSM-5020	TSM-5035	TSM-5050

2:1 ROPING DUTY TABLE FOR MRL- 8MM ROPE

Capacity (lbs)	Speed (fpm)					
	100	150	200	250	300	350
2500	TPM1-2515		TPM2-2520-8mm	TPM2-2535-8mm		
	TMSM1-2520			TMSM1-2535		
3500	TPM3-3520			TPM3-3535		
	TMSM2-3520			TMSM2-3535		

Power Wiring Diagram

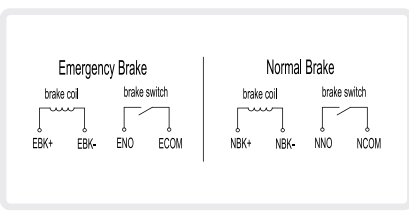
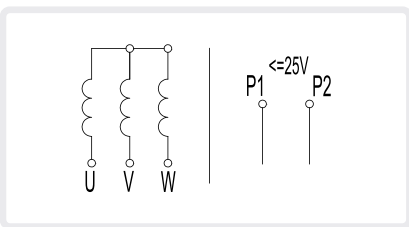

> Brake Wiring Diagram

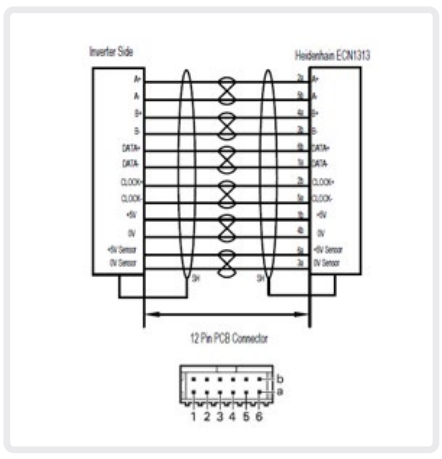

> Encoder Connection Terminal



TPM1
SERIES 8MM ROPE

MRL PM
GEARLESS MACHINE

- **SHEAVE SHAFT LOAD:** 6,587 lbs
- **SHEAVE GROOVES:** Up to 4X8mm ropes
- **ESTIMATED WEIGHT:** 660 lbs
- **NORMAL BRAKE**
 - Pick/Hold Voltage: 90/45 VDC
 - Pick/Hold Current: 1.2/0.6 A
- **EMERGENCY BRAKE**
 - Pick/Hold Voltage: 90/45 VDC
 - Pick/Hold Current: 1.2/0.6 A



MODEL NUMBER	Capacity (lbs)	Speed (fpm)	Roping	Motor Rating (HP)	Poles	Rated Motor RPM	Rated Voltage (VAC)	Rated Frequency (HZ)	Rated Current (A)	Rated Torque (ft-lbs)	Max Acceleration Torque (ft-lbs)	Cwt (%)	Sheave Diameter
TPM1-2515-HV/LV	2500	150	2:1	6.7	20	86	290/145	14.3	13.5/26.5	410	820	50	13.39"

TPM2
SERIES 8MM ROPE

MRL PM
GEARLESS MACHINE

- **SHEAVE SHAFT LOAD:** 6,587 lbs
- **SHEAVE GROOVES:** Up to 7X8mm ropes
- **ESTIMATED WEIGHT:** 990 lbs
- **NORMAL BRAKE**
 - Pick/Hold Voltage: 90/45 VDC
 - Pick/Hold Current: 0.87/0.44 A
- **EMERGENCY BRAKE**
 - Pick/Hold Voltage: 90/45 VDC
 - Pick/Hold Current: 0.87/0.44 A



MODEL NUMBER	Capacity (lbs)	Speed (fpm)	Roping	Motor Rating (HP)	Poles	Rated Motor RPM	Rated Voltage (VAC)	Rated Frequency (HZ)	Rated Current (A)	Rated Torque (ft-lbs)	Max Acceleration Torque (ft-lbs)	Cwt (%)	Sheave Diameter
TPM2-2520-HV/LV-8mm	2500	200	2:1	10.6	20	112	328/160	18.7	17.7/35.8	494	988	45	13.39"
TPM2-2535-HV/LV-8mm	2500	350	2:1	18.7	20	198	328/160	33	30.4/61.5	494	988	45	13.39"

TPM2

SERIES 10MM ROPE

MRL PM GEARLESS MACHINE

- > **SHEAVE SHAFT LOAD:** 6,587 lbs
- > **SHEAVE GROOVES:** Up to 6X10mm ropes
- > **ESTIMATED WEIGHT:** 1,012 lbs
- > **NORMAL BRAKE**
 - > Pick/Hold Voltage: 90/45 VDC
 - > Pick/Hold Current: 1.08/0.54 A
- > **EMERGENCY BRAKE**
 - > Pick/Hold Voltage: 90/45 VDC
 - > Pick/Hold Current: 1.08/0.54 A

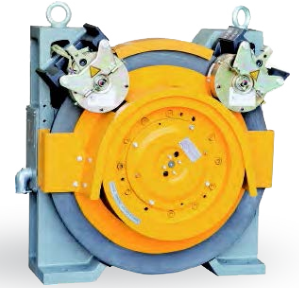

MODEL NUMBER	Capacity (lbs)	Speed (fpm)	Roping	Motor Rating (HP)	Poles	Rated Motor RPM	Rated Voltage (VAC)	Rated Frequency (HZ)	Rated Current (A)	Rated Torque (ft-lbs)	Max Acceleration Torque (ft-lbs)	Cwt (%)	Sheave Diameter
TPM2-2520-HV/LV-10mm	2500	200	2:1	9	20	96	328/160	16	15.7/30.6	494	988	50	15.75"
TPM2-2535-HV/LV-10mm	2500	350	2:1	15.7	20	167	328/160	27.8	26.7/53.7	494	988	50	15.75"

TPM3

SERIES 8MM ROPE

MRL PM GEARLESS MACHINE

- > **SHEAVE SHAFT LOAD:** 9,900 lbs
- > **SHEAVE GROOVES:** Up to 7X8mm ropes
- > **ESTIMATED WEIGHT:** 1,045 lbs
- > **NORMAL BRAKE**
 - > Pick/Hold Voltage: 90/45 VDC
 - > Pick/Hold Current: 1.08/0.54 A
- > **EMERGENCY BRAKE**
 - > Pick/Hold Voltage: 90/45 VDC
 - > Pick/Hold Current: 1.08/0.54 A

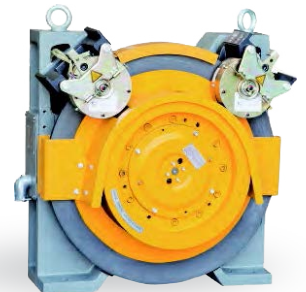

MODEL NUMBER	Capacity (lbs)	Speed (fpm)	Roping	Motor Rating (HP)	Poles	Rated Motor RPM	Rated Voltage (VAC)	Rated Frequency (HZ)	Rated Current (A)	Rated Torque (ft-lbs)	Max Acceleration Torque (ft-lbs)	Cwt (%)	Sheave Diameter
TPM3-3520-HV/LV	3500	200	2:1	12.6	20	112	328/160	18.7	20.3/42.8	590	1180	50	13.39"
TPM3-3535-HV/LV	3500	350	2:1	22.3	20	198	328/160	33	35.2/70.4	590	1180	50	13.39"

TPM4 SERIES

MRL PM GEARLESS MACHINE

- **SHEAVE SHAFT LOAD:** 9,900 lbs
- **SHEAVE GROOVES:** Up to 6X10mm or 7X8mm ropes
- **ESTIMATED WEIGHT:** 1,188 lbs, 1,266 lbs for 8mm ropes
- **NORMAL BRAKE**
 - Pick/Hold Voltage: 90/45 VDC
 - Pick/Hold Current: 1.08/0.54 A
- **EMERGENCY BRAKE**
 - Pick/Hold Voltage: 90/45 VDC
 - Pick/Hold Current: 1.74/0.88 A



MODEL NUMBER	Capacity (lbs)	Speed (fpm)	Roping	Motor Rating (HP)	Poles	Rated Motor RPM	Rated Voltage (VAC)	Rated Frequency (HZ)	Rated Current (A)	Rated Torque (ft-lbs)	Max Acceleration Torque (ft-lbs)	Cwt (%)	Sheave Diameter
TPM4-3520-HV/LV	3500	200	2:1	12.3	20	96	328/160	16	21.1/40	676	1352	50	15.75"
TPM4-3535-HV/LV	3500	350	2:1	21.6	20	167	328/160	27.8	34/67	676	1352	50	15.75"
TPM4-4035-HV-8MM	4000	350	2:1	25.0	20	198	328	33.3	39.8	656	1313	50	13.39"

TSM SERIES 10MM ROPE

MRL PM GEARLESS MACHINE

- **SHEAVE SHAFT LOAD:** 12,817 lbs
- **SHEAVE GROOVES:** Up to 8X10mm ropes
- **ESTIMATED WEIGHT:** 2,090 lbs
- **NORMAL BRAKE**
 - Pick/Hold Voltage: 90/45 VDC
 - Pick/Hold Current: 2.05/1.00 A
- **EMERGENCY BRAKE**
 - Pick/Hold Voltage: 90/45 VDC
 - Pick/Hold Current: 2.05/1.00 A

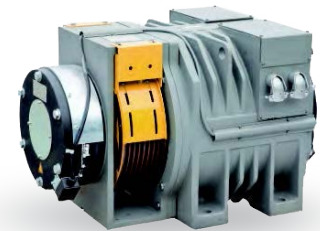

MODEL NUMBER	Capacity (lbs)	Speed (fpm)	Roping	Motor Rating (HP)	Poles	Rated Motor RPM	Rated Voltage (VAC)	Rated Frequency (HZ)	Rated Current (A)	Rated Torque (ft-lbs)	Max Acceleration Torque (ft-lbs)	Cwt (%)	Sheave Diameter
TSM-3535-HV	3500	350	2:1	21.9	20	155	350	25.8	32.9	743	1858	50	17.32"
TSM-3550-HV	3500	500	2:1	31.3	20	221	350	35.8	46.5	743	1858	50	17.32"
TSM-5020-HV	5000	200	2:1	17.6	20	87	350	14.5	27.6	1061	2653	50	17.32"
TSM-5035-HV	5000	350	2:1	31.3	20	155	350	25.8	46.9	1061	2653	50	17.32"
TSM-5050-HV	5000	500	2:1	45	20	221	350	36.8	66.7	1061	2653	50	17.32"

TMSM1

SERIES 8MM ROPE

MRL PM GEARLESS MACHINE

- > **SHEAVE SHAFT LOAD:** 8,500 lbs
- > **SHEAVE GROOVES:** Up to 8X8mm ropes
- > **ESTIMATED WEIGHT:** 985 lbs
- > **NORMAL BRAKE**
 - > Pick/Hold Voltage: 90/45 VDC
 - > Pick/Hold Current: 1.25/0.69 A
- > **EMERGENCY BRAKE**
 - > Pick/Hold Voltage: 90/45 VDC
 - > Pick/Hold Current: 2.05/1.0 A



MODEL NUMBER	Capacity (lbs)	Speed (fpm)	Roping	Motor Rating (HP)	Poles	Rated Motor RPM	Rated Voltage (VAC)	Rated Frequency (HZ)	Rated Current (A)	Rated Torque (ft-lbs)	Max Acceleration Torque (ft-lbs)	CWT (%)	Sheave Diameter
TMSM1-2520	2500	200	2:1	10.7	20	121	340	20.2	17	465	930	45	12.6"
TMSM1-2535	2500	350	2:1	18.8	20	212	340	35.3	28	465	930	45	12.6"

TMSM2

SERIES 8MM ROPE

MRL PM GEARLESS MACHINE

- > **SHEAVE SHAFT LOAD:** 10,000 lbs
- > **SHEAVE GROOVES:** Up to 8X8mm ropes
- > **ESTIMATED WEIGHT:** 1,180 lbs
- > **NORMAL BRAKE**
 - > Pick/Hold Voltage: 90/45 VDC
 - > Pick/Hold Current: 2.05/1.0 A
- > **EMERGENCY BRAKE**
 - > Pick/Hold Voltage: 90/45 VDC
 - > Pick/Hold Current: 2.05/1.0 A



MODEL NUMBER	Capacity (lbs)	Speed (fpm)	Roping	Motor Rating (HP)	Poles	Rated Motor RPM	Rated Voltage (VAC)	Rated Frequency (HZ)	Rated Current (A)	Rated Torque (ft-lbs)	Max Acceleration Torque (ft-lbs)	CWT (%)	Sheave Diameter
TMSM2-3520	3500	200	2:1	14.8	20	121	340	20.2	23	642	1284	45	12.6"
TMSM2-3535	3500	350	2:1	25.9	20	212	340	35.3	40	642	1284	45	12.6"

MACHINE ROOMLESS (MRL)

Technical Details

TPM1 SERIES

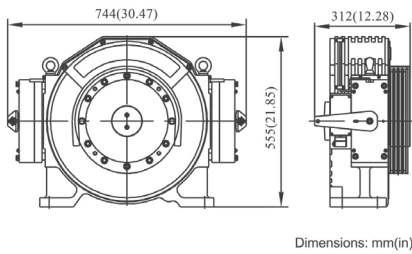

Dimensions: mm(in)

TPM2 SERIES

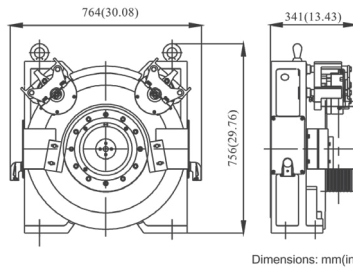

Dimensions: mm(in)

TPM3 SERIES

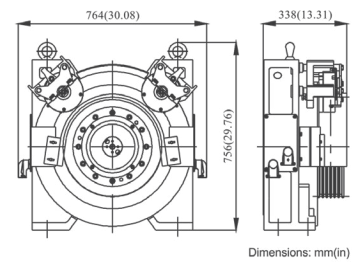

Dimensions: mm(in)

TPM4 SERIES

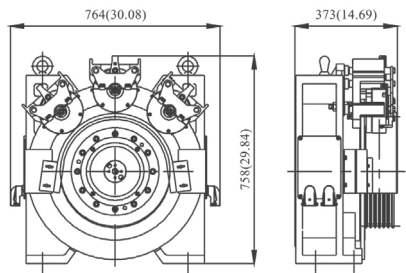

Dimensions: mm(in)

TSM SERIES

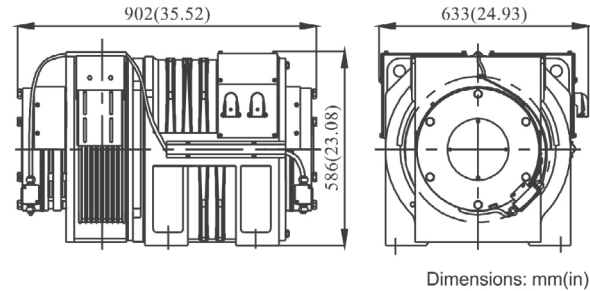

Dimensions: mm(in)

TMSM1 SERIES

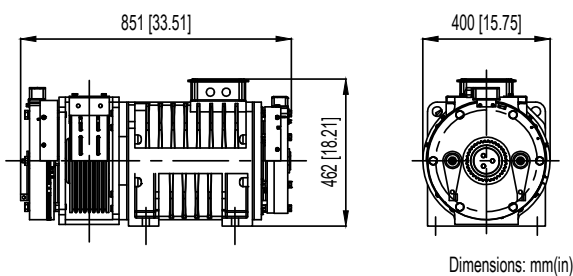

Dimensions: mm(in)

TMSM2 SERIES

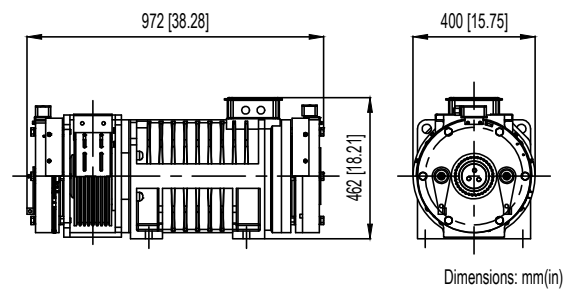

Dimensions: mm(in)

MACHINES IN STOCK

4 Week Lead
Times



Email _____

✉ TorinDrive@Hyperion-Solutions.com

ELEVATOR
TRACTION MACHINE

BASEMENT MACHINE

TGD-B/TMGL-B

> TMGL-B SERIES

- > Ideal for Geared Basement to Gearless Mod
- > Optional Emergency Brake Available

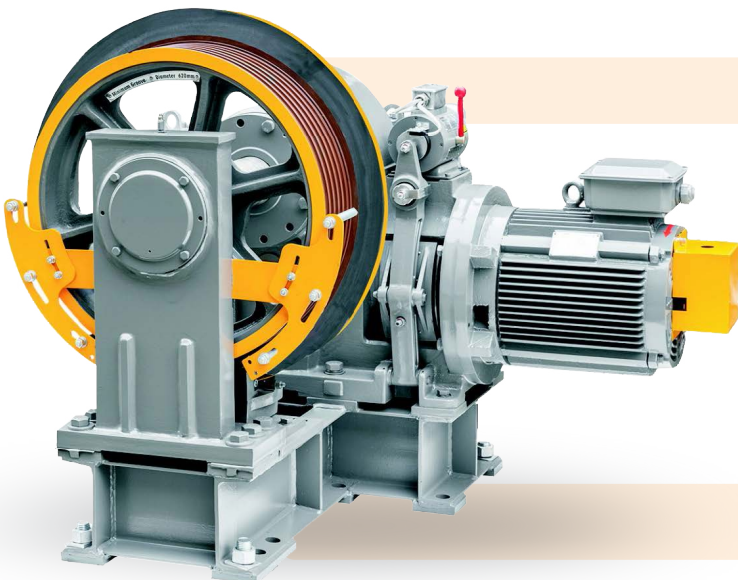
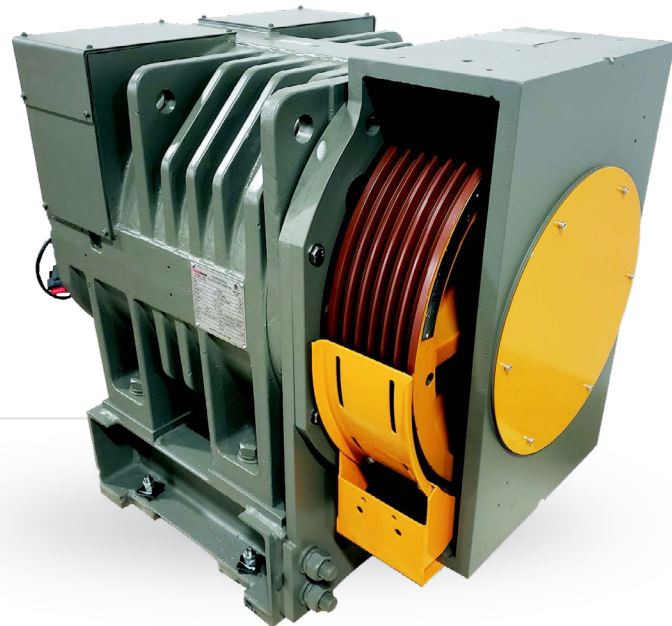

TGD-B SERIES

- > Geared Basement Machine
- > Emergency Brake Pre-Installed





1:1 Roping or 2:1 Roping Single Wrap TGD-B/TMGL-B SERIES

**BASEMENT
MACHINE
APPLICATION
TABLE**

- > A17.1 Compliance
- > CSA B44.1/ASTM A17.5 Certification (CSA File No.243553)
- > Geared machine comes with bronze gear
- > Geared machine with Incremental encoder and Gearless machine with Absolute encoder: both 2048 PPR
- > TGD-B can be ordered as Right hand or Left hand
- > TGD1B series have high voltage (480V) and low voltage (208V) options
- > Controller UPS battery is needed to electrically operate the brakes in case of power outage for TMGL-B

PART NUMBER ILLUSTRATION

TGD1B ▾	25 ▾	35 ▾	HV ▾	R ▾	SC ▾	1/2 ▾
Geared Basement Machine Series	Capacity 2500lbs	Speed 350fpm	Voltage 480V	Hand Right	Emergency brake Sheave Clamp	Rope Size 1/2"

1:1 Roping Duty Table for Geared Basement Machine

Capacity (lbs)	Speed (fpm)										
	50	100	150	200	250	300	350	400	450	500	
1500	TGD1B-2510-SC		TGD1B-2020-SC		TGD1B-2535-SC			TGD1B-2540-SC		TGD3B-3545-SC	
2000			TGD1B-2520-SC								
2500	TGD3B-5020		TGD3B-4535-SC			TGD3B-4540		TGD3B-4545		TGD3B-3550	
3000											
3500											
4000											
4500	TGD3B-5520-SC		TGD3B-5535			TGD3B-5545-SC					
5000											
5500	TGD3B-5520-SC		TGD3B-5535			TGD3B-5545-SC					
6000	TGD3B-5520		TGD3B-6035			TGD3B-6045					

1:1 ROPING DUTY TABLE FOR GEARLESS BASEMENT MACHINE

Capacity (lbs)	Speed (fpm)		
	200	350	500
2500	TMGL2AB-2520	TMGL2AB-2535	TMGL2AB-3050
3000	TMGL2AB-3035		

2:1 ROPING DUTY TABLE FOR GEARLESS BASEMENT

Capacity (lbs)	Speed (fpm)	
	500	700
5000	TMGL2AB-2-1-5050	TMGL2AB-2-1-5070

Power Wiring Diagram

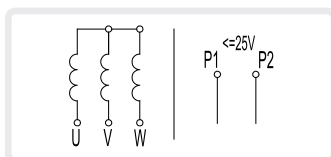

> Single Voltage

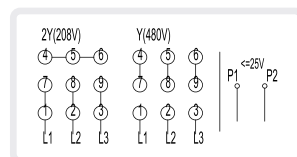

> Dual Voltage

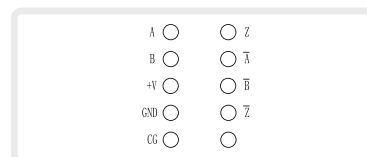

> Incremental Encoder Terminal

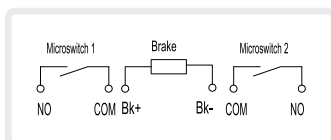

> Normal Brake Wiring Diagram for TGD-B

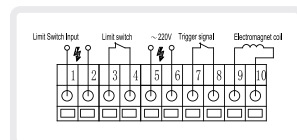

> Sheave Clamp Wiring Diagram for TGD-B

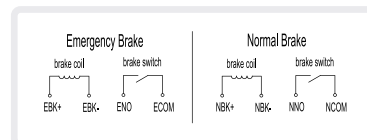

> Brake Wiring Diagram for TMGL-B

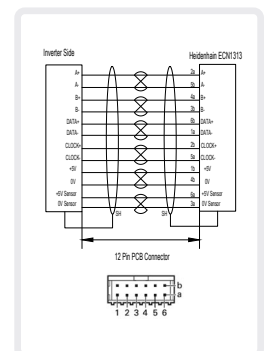

> Absolute Encoder Connection Terminal



TGD1B SERIES

BASEMENT GEARED MACHINE

- **SHEAVE SHAFT LOAD:** 14,300 lbs
- **SHEAVE GROOVES:** Up to 6X1/2" or 5X5/8" ropes
- **ESTIMATED WEIGHT:** 2,050 lbs
- **NORMAL BRAKE**
 - Pick/Hold Voltage: 110/65 VDC
 - Pick/Hold Current: 2.0/1.18 A



MODEL NUMBER	Capacity (lbs)	Speed (fpm)	Roping	Motor Rating (HP)	Poles	Rated Motor RPM	Rated Voltage (VAC)	Rated Frequency (HZ)	Rated FLA (A)	No Load Current (A)	Gear Ratio	Application Motor RPM	Cwt (%)	Sheave Diameter
TGD1B-2020-HV/LV	2000	200	1:1	15	4	1770	480/208	60	17/39	7.8/15	50:1	1493	40	25.6"
TGD1B-2510-HV/LV	2500	100	1:1	10	6	1170	480/208	60	14/32	8.9/19.5	61:1	911	40	25.6"
TGD1B-2520-HV/LV	2500	200	1:1	20	4	1775	480/208	60	23/53	11/24	50:1	1493	40	25.6"
TGD1B-2535-HV/LV	2500	350	1:1	25	4	1770	480/208	60	28/64	12/27	61:2	1593	40	25.6"
TGD1B-2540-HV/LV	2500	400	1:1	30	4	1775	480/208	60	33/75	14/29	55:2	1642	40	25.6"

TGD1B-SC SERIES

BASEMENT GEARED MACHINE

- **SHEAVE SHAFT LOAD:** 14,300 lbs
- **SHEAVE GROOVES:** Up to 6X1/2" or 5X5/8" ropes
- **ESTIMATED WEIGHT:** 2,450 lbs
- **NORMAL BRAKE**
 - Pick/Hold Voltage: 110/65 VDC
 - Pick/Hold Current: 2.0/1.18 A
- **EMERGENCY BRAKE**
 - Pick/Hold Voltage: AC220 (always on)
 - Pick/Hold Current: 0.24/0.12 A

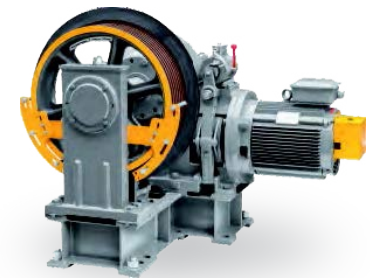

MODEL NUMBER	Capacity (lbs)	Speed (fpm)	Roping	Motor Rating (HP)	Poles	Rated Motor RPM	Rated Voltage (VAC)	Rated Frequency (HZ)	Rated FLA (A)	No Load Current (A)	Gear Ratio	Application Motor RPM	Cwt (%)	Sheave Diameter
TGD1B-2020-HV/LV-SC	2000	200	1:1	15	4	1720	480/208	60	17/39	7.8/15	50:1	1493	40	25.6"
TGD1B-2510-HV/LV-SC	2500	100	1:1	10	6	1175	480/208	60	14/32	8.9/19.5	61:1	911	40	25.6"
TGD1B-2520-HV/LV-SC	2500	200	1:1	20	4	1775	480/208	60	23/53	11/24	50:1	1493	40	25.6"
TGD1B-2535-HV/LV-SC	2500	350	1:1	25	4	1775	480/208	60	28/64	12/27.4	61:2	1593	40	25.6"
TGD1B-2540-HV/LV-SC	2500	400	1:1	30	4	1775	480/208	60	33/75	14/29	55:2	1642	40	25.6"

TGD3B SERIES

BASEMENT GEARED MACHINE

- **SHEAVE SHAFT LOAD:** 27,500 lbs
- **SHEAVE GROOVES:** Up to 8X5/8" rope (1/2" rope option may available)
- **ESTIMATED WEIGHT:** 3,520 lbs
- **NORMAL BRAKE**
 - Pick/Hold Voltage: 200/118 VDC
 - Pick/Hold Current: 4.0/2.36 A
- **EMERGENCY BRAKE**
 - Pick/Hold Voltage: AC220 (always on)
 - Pick/Hold Current: 0.24/0.12 A

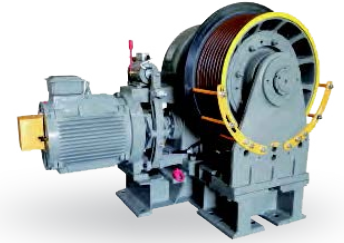

MODEL NUMBER	Capacity (lbs)	Speed (fpm)	Roping	Motor Rating (HP)	Poles	Rated Motor RPM	Rated Voltage (VAC)	Rated Frequency (HZ)	Rated FLA (A)	No Load Current (A)	Gear Ratio	Application Motor RPM	Cwt (%)	Sheave Diameter
TGD3B-3545-HV-SC	3500	450	1:1	50	4	1770	480	60	55	19	82:3	1705	40	27.6"
TGD3B-3550-HV*	3500	500	1:1	50	4	1770	480	60	55	19	82:3	1657	40	31.5"
TGD3B-4535-HV-SC	4500	350	1:1	50	4	1770	480	60	55	19	69:2	1674	40	27.6"
TGD3B-4540-HV-SC	4500	400	1:1	50	4	1770	480	60	55	19	61:2	1691	40	27.6"
TGD3B-4545-HV-SC	4500	450	1:1	60	4	1770	480	60	66	21	82:3	1705	40	27.6"
TGD3B-5020-HV-SC	5000	200	1:1	35	4	1770	480	60	40	15	61:1	1691	40	27.6"
TGD3B-5520-HV-SC	5500	200	1:1	35	4	1770	480	60	40	15	61:1	1691	45	27.6"
TGD3B-5535-HV-SC	5500	350	1:1	50	4	1770	480	60	55	19	69:2	1674	45	27.6"
TGD3B-5545-HV-SC	5500	450	1:1	60	4	1770	480	60	66	21	82:3	1705	40	27.6"
TGD3B-6020-HV*	6000	200	1:1	40	4	1770	480	60	45	16	61:1	1691	40	27.6"
TGD3B-6035-HV*	6000	350	1:1	60	4	1770	480	60	66	21	69:2	1674	40	27.6"
TGD3B-6045-HV*	6000	450	1:1	60	4	1770	480	60	66	21	61:2	1665	45	31.5"

* No sheave clamp is available for these machine models

BASEMENT MACHINE

Technical Details

TGD1B SERIES

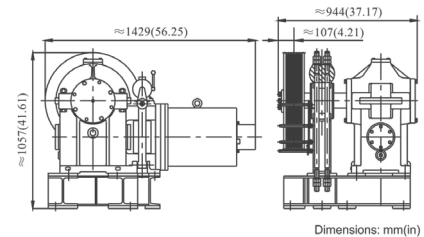

TGD1B-SC SERIES

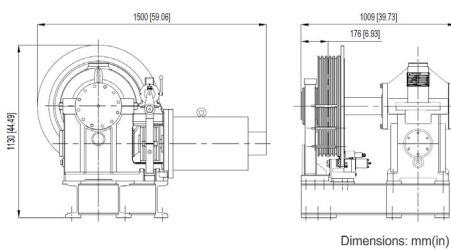

TGD3B SERIES

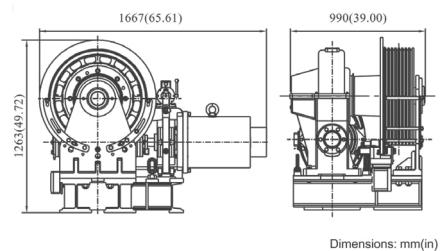

TMGL2AB SERIES

BASEMENT GEARLESS MACHINE

- **SHEAVE SHAFT LOAD:** 11,250 lbs
- **SHEAVE GROOVES:** Up to 6X1/2" ropes
- **ESTIMATED WEIGHT:** 2,500 lbs
- **NORMAL BRAKE**
 - Pick/Hold Voltage: 90/45 VDC
 - Pick/Hold Current: 2.05/1.0 A
- **EMERGENCY BRAKE**
 - Pick/Hold Voltage: 90/45 VDC
 - Pick/Hold Current: 2.05/1.0 A

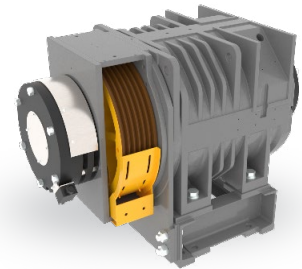

MODEL NUMBER	Capacity (lbs)	Speed (fpm)	Roping	Motor Rating (HP)	Poles	Rated Motor RPM	Rated Voltage (VAC)±5%	Rated Frequency (HZ)	Rated Current (A)	Rated Torque (ft-lbs)	Max Acceleration Torque (ft-lbs)	CWT (%)	Sheave Diameter
TMGL2AB-2520-HV/LV	2500	200	1:1	9.3	20	38	350/160	6.4	14.8/30.7	1272	3180	45	20"
TMGL2AB-2535-HV/LV	2500	350	1:1	16.2	20	67	350/160	11.1	24.5/52.4	1272	3180	45	20"
TMGL2AB-3035-HV/LV	3000	350	1:1	19.4	20	67	350/160	11.1	29.8/61.5	1527	3817	45	20"
TMGL2AB-3050-HV	3000	500	1:1	27.7	20	95	350	15.9	42	1527	3817	45	20"
TMGL2AB-2-1-5050-HV	5000	500	2:1	49.1	20	191	350	31.8	68.5	1350	3375	45	20"
TMGL2AB-2-1-5070-HV	5000	700	2:1	72.2	20	267	350	44.5	108	1420	3550	45	20"

TMGL2AB-NEB SERIES

BASEMENT GEARLESS MACHINE

- **SHEAVE SHAFT LOAD:** 11,915 lbs
- **SHEAVE GROOVES:** Up to 6X1/2" ropes
- **ESTIMATED WEIGHT:** 2,500 lbs
- **NORMAL BRAKE**
 - Pick/Hold Voltage: 90/45 VDC
 - Pick/Hold Current: 2.05/1.0 A

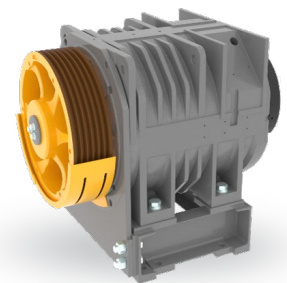

MODEL NUMBER	Capacity (lbs)	Speed (fpm)	Roping	Motor Rating (HP)	Poles	Rated Motor RPM	Rated Voltage (VAC)±5%	Rated Frequency (HZ)	Rated Current (A)	Rated Torque (ft-lbs)	Max Acceleration Torque (ft-lbs)	CWT (%)	Sheave Diameter
TMGL2AB-2520-HV/LV-NEB	2500	200	1:1	9.3	20	38	350/160	6.4	14.8/30.7	1272	3180	45	20"
TMGL2AB-2535-HV/LV-NEB	2500	350	1:1	16.2	20	67	350/160	11.1	24.5/52.4	1272	3180	45	20"
TMGL2AB-3035-HV/LV-NEB	3000	350	1:1	19.4	20	67	350/160	11.1	29.8/61.5	1527	3817	45	20"
TMGL2AB-3050-HV-NEB	3000	500	1:1	27.7	20	95	350	15.9	42	1527	3817	45	20"
TMGL2AB-2-1-5050-HV-NEB	5000	500	2:1	49.1	20	191	350	31.8	68.5	1350	3375	45	20"
TMGL2AB-2-1-5070-HV-NEB	5000	700	2:1	72.2	20	267	350	44.5	108	1420	3550	45	20"

Customized Solutions.



Email _____

✉ TorinDrive@Hyperion-Solutions.com

BASEMENT MACHINE

Technical Details

TMGL2AB SERIES

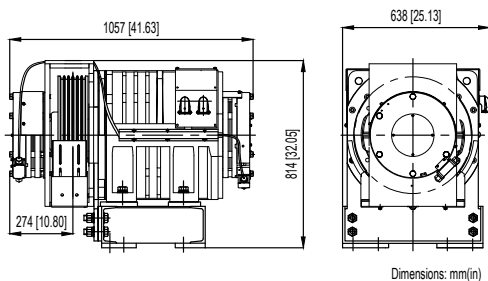

TMGL2AB-NEB SERIES

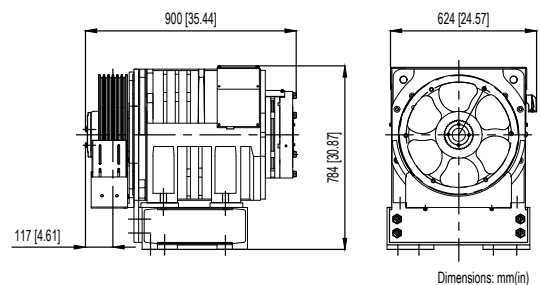

ELEVATOR SYSTEMS ACCESSORIES

➤ ROPE LUBRICATOR



➤ OPTIONAL SECONDARY AND DEFLECTOR SHEAVES



➤ OIL BUFFER

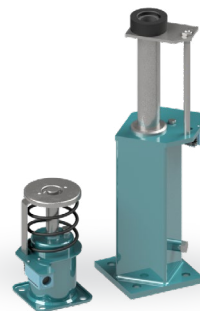

➤ WIRE ROPE



➤ WEDGE SOCKETS



➤ ZIPPCO GOVERNOR



➤ ROLLER GUIDES

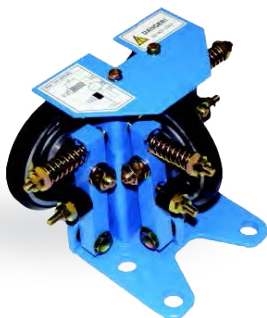

➤ ROPE BRAKE

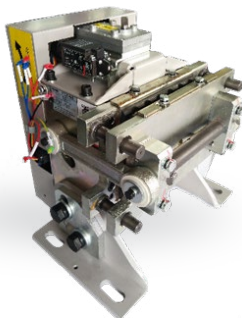

➤ SAFETY GEAR

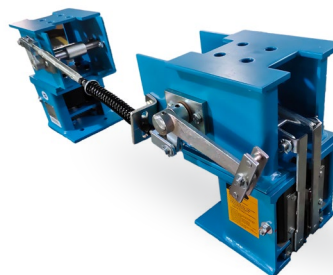



ABOUT US

Established in 2008, Torin Drive North America has been a leading provider of elevator components and services tailored to meet the unique demands of the North American market. Based in Memphis, TN, our 200,000 square foot headquarters serves as the hub for our innovative solutions.

We specialize in Torin Drive Geared and Gearless machines, A17 compliant and CSA certified for the utmost safety and quality. Our expertise extends to custom engineering with tailored solutions for modernization. Additional offerings include Bedplates, Deflectors, Rope Guards, Wire Ropes, and more.

With our warehouse stocked with popular machines and replacement parts, we prioritize efficiency and reduced lead times. Our 36,000+ car install base across North America attests to our reliability and market presence.

Our dedicated team of experienced professionals ensures comprehensive technical support. Fully insured and licensed in the US, we're committed to offering the best products and services specifically designed and rigorously tested for the North American market. Contact us for quoting, custom engineering design, and order assistance via phone or email.

Thank you for choosing Torin Drive North America—your trusted partner for elevator solutions, delivering reliability, expertise, and dedicated support.

TORINDRIVE

NORTH AMERICA

A Brand of **HYPERION**



Torin Drive North America
4949 E. Raines Rd, Suite 101 Memphis,
TN 38118, USA



torindrive@hyperion-solutions.com



(901) 290-1600